

7002024301

www.megalite.com info@megalite.com

Megalite

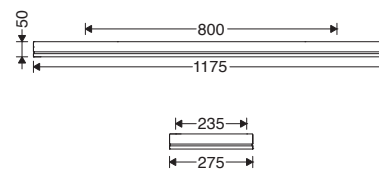

M324R...

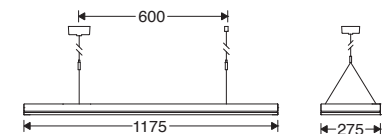

M324R... +G421RKSU2-W

Use the provided stencil tool within the carton to make holes (*) on ceilings.
NOTE: The holes on the stencil tool and the terminals on the luminaire must be in the same direction. (Figure 3)

- ⚠
- 1- For proper utilization of this product and safety, it is mandatory to closely comply with the directions and notes in this instruction and guide.
 - 2- Do not directly touch or impact LED module.
 - 3- Do not stare at LED light source.

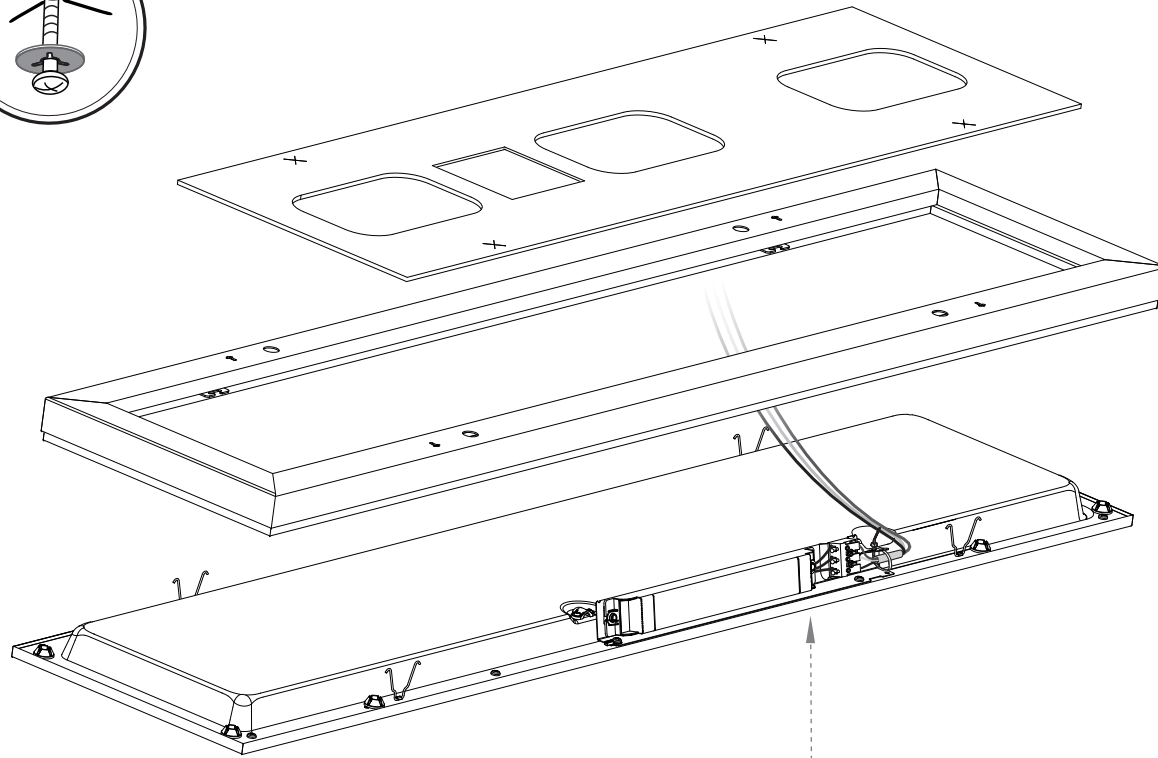
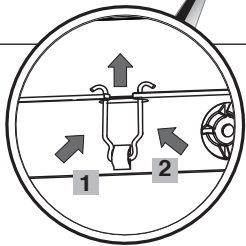
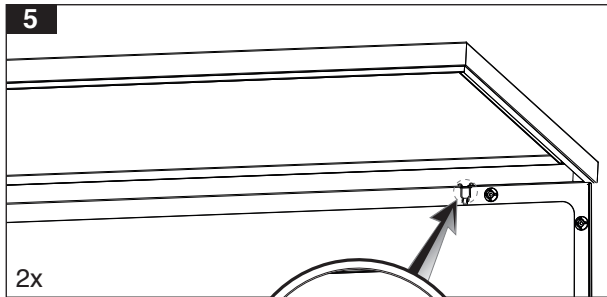
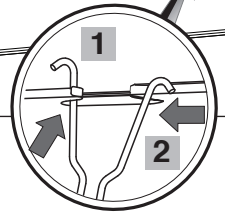
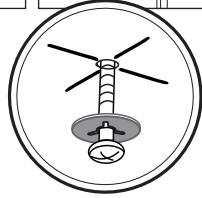
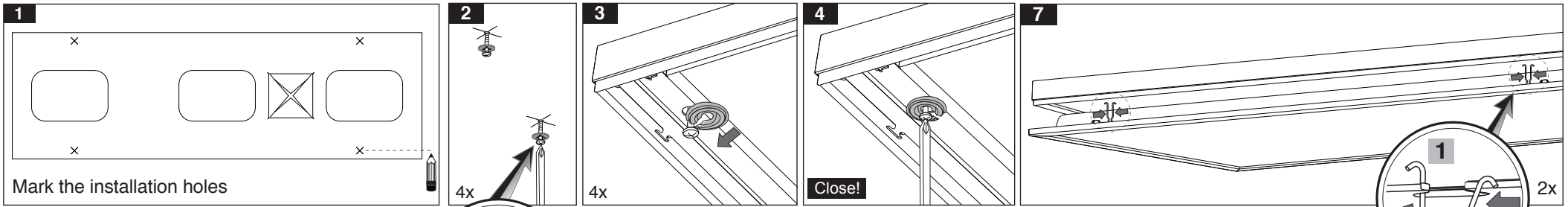

Electrical connections

